

**EcoTRAVERS®**

# INSTALLATION GUIDE

---

Composite decking system

[www.ecotravers.pl](http://www.ecotravers.pl)

**CONCRETE SLAB**



# Table of contents

---

Security measures	3
System components	4
List of necessary tools	5
Preparing a base	5
Installing joists on a concrete base	6
Installation on pedestals	7
Decking boards installation	8
Longitudinal board alignment	12
Decking trims	13



Thank you for your trust and purchasing our products.  
Before starting the installation read the instructions carefully.

## SAFETY MEASURES



**The installation should be carried out by specialized construction companies.**

Ecotravers is not responsible for any damages or product defects resulting from improper installation. Installation that does not comply with the instructions below voids the consumer's warranty rights.



**Boards should not be installed during precipitations or at temperatures below 5°C.**

Before starting the installation, all boards and profiles should undergo a 24-hour acclimatization period at the installation site.



**For cutting Ecotravers components, we recommend using a metal/aluminum cutting circular saw with fine teeth or a diamond finish.**

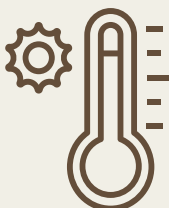

**The components of the Ecotravers composite terrace system are not suitable for constructing structures.**

All components expand under high temperatures, therefore it is essential to install the boards with proper gaps. The specific size of the required gaps will be provided in the further sections of the instructions.

## SYSTEM COMPONENTS

EcoTravers decking system includes:

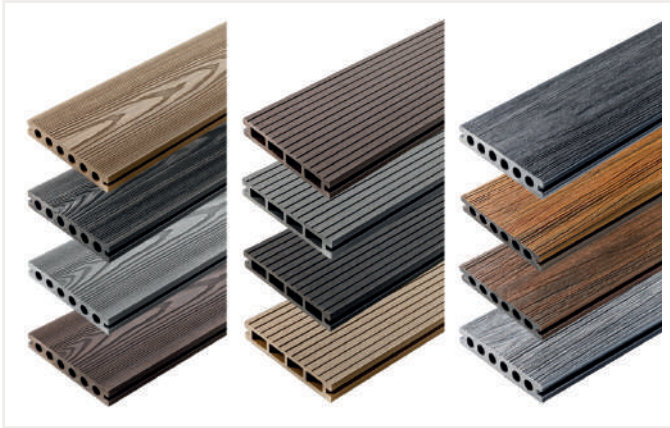

**Composite decking board**

Length: 2,4-4 m

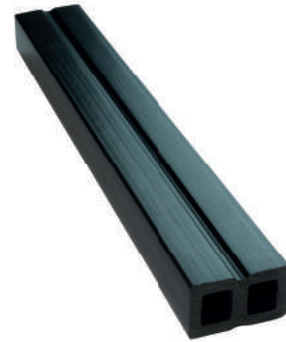

**Joists**

Composite 50x30 & 40x20 mm; aluminum 50x30 mm

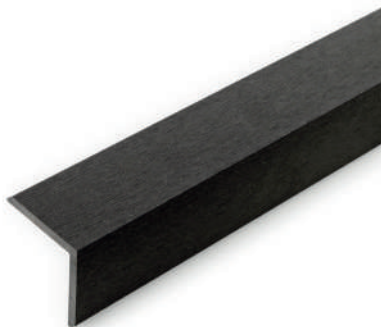

**Corner/edge trim**



**Skirting trim**



**Mounting clips**



**Adjustable pedestals**

Adjustment range: 10-220 mm

## Necessary tools

---

- Circular or table saw – preferably with a diamond blade or fine teeth for cutting
- Impact drill for mounting joists to concrete
- Screw gun – for convenience, we recommend using two screw guns: one for drilling and the other for screwing
- Hammer and rubber mallet
- Level
- Pencil
- Measuring tape
- Conical reamer for the screw gun
- Drill bit set: 6 mm for concrete, 6 & 3 mm for metal
- Bit torx T15
- Adhesive (optional)
- Quick installation anchors for concrete: 6 mm x 60 mm or 6 mm x 80 mm
- Anchor screws
- Stainless steel screws for metal with a small thread: 3,5 x 25 mm (for mounting joists to pedestals)

## Preparing a base

---

Ecotravers decking boards should be installed on a previously prepared base. The prepared substrate should comply with the applicable regulations and construction standards.

- ✔ In the case of a concrete screed, it should be flat, even, and well-leveled. The floor can be pre-protected before installation at your discretion.
- ✔ For small home terraces, it is possible to use concrete blocks (spaced at 35 cm intervals) if the ground is properly prepared with a sub-base.
- ✔ When installing on styrofoam or styrodur, it should have a minimum hardness of 250 EPS, and additional shims or brackets should be used.
- ✔ During the installation of the boards, a 10 mm expansion gap should be maintained between the decking and walls or other fixed elements.

### The instructions pertain to installation on:

- a concrete slab
- adjustable pedestals

## Installing joists on a concrete slab

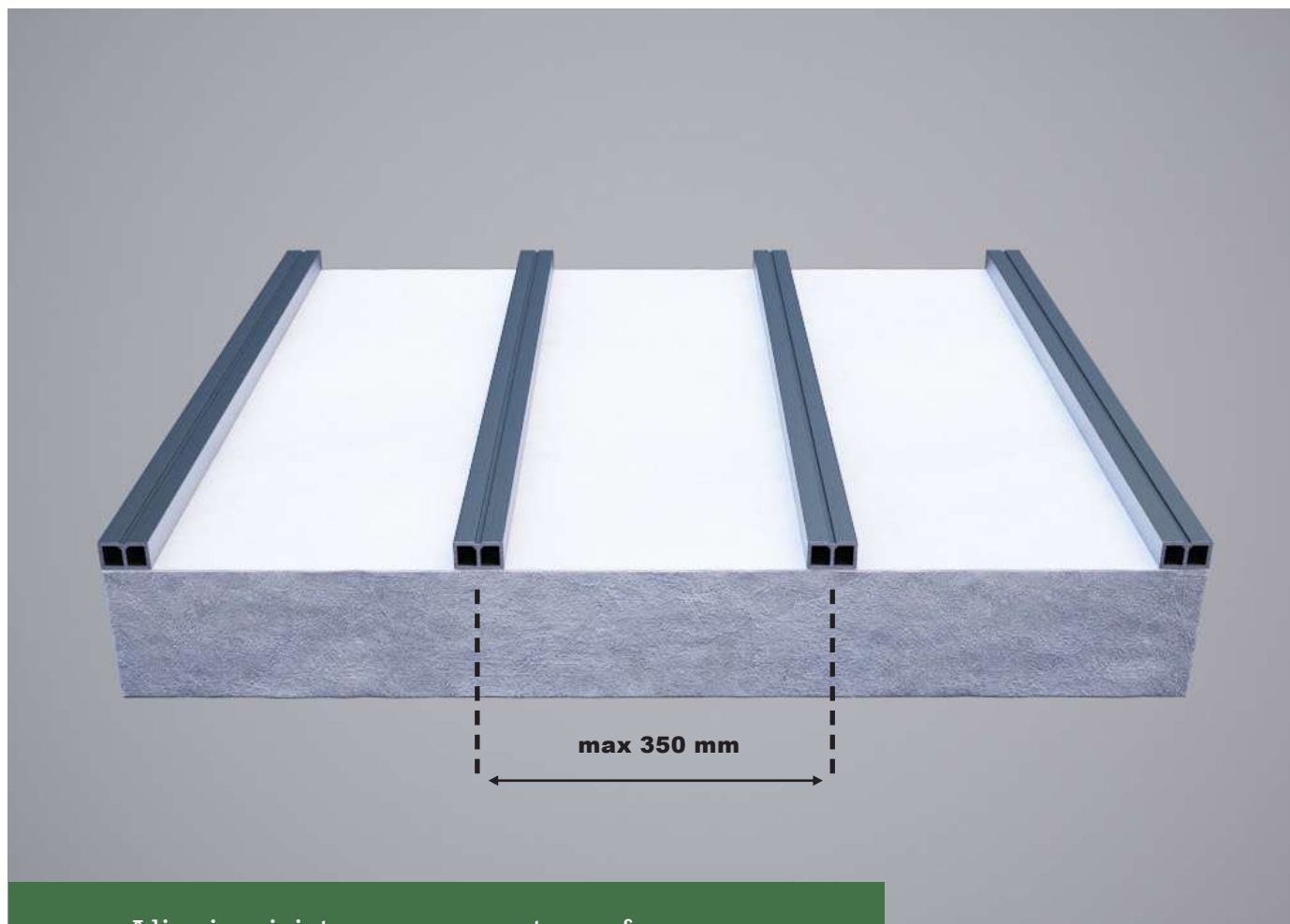

Aligning joists on a concrete surface

The concrete surface should be stable and flat, with a slope of 0.5% – 5 mm per 1 m – in the opposite direction of the building walls. This layout ensures optimal water drainage from the terrace, preventing water from pooling on the boards and underneath them. The joists should be laid parallel to each other at maximum intervals of 350 mm from their center, with deep grooves facing upwards. Leave 10 mm gaps between the joist and the wall or any other fixed elements.



### Before installation, please remember:

- The joists should not be embedded in the concrete.
- The maximum distance between the joists should not exceed 350 mm.
- The boards should not be directly fastened or glued to the concrete.
- The concrete slab should be constructed according to the applicable regulations and building standards.

## Installation on pedestals

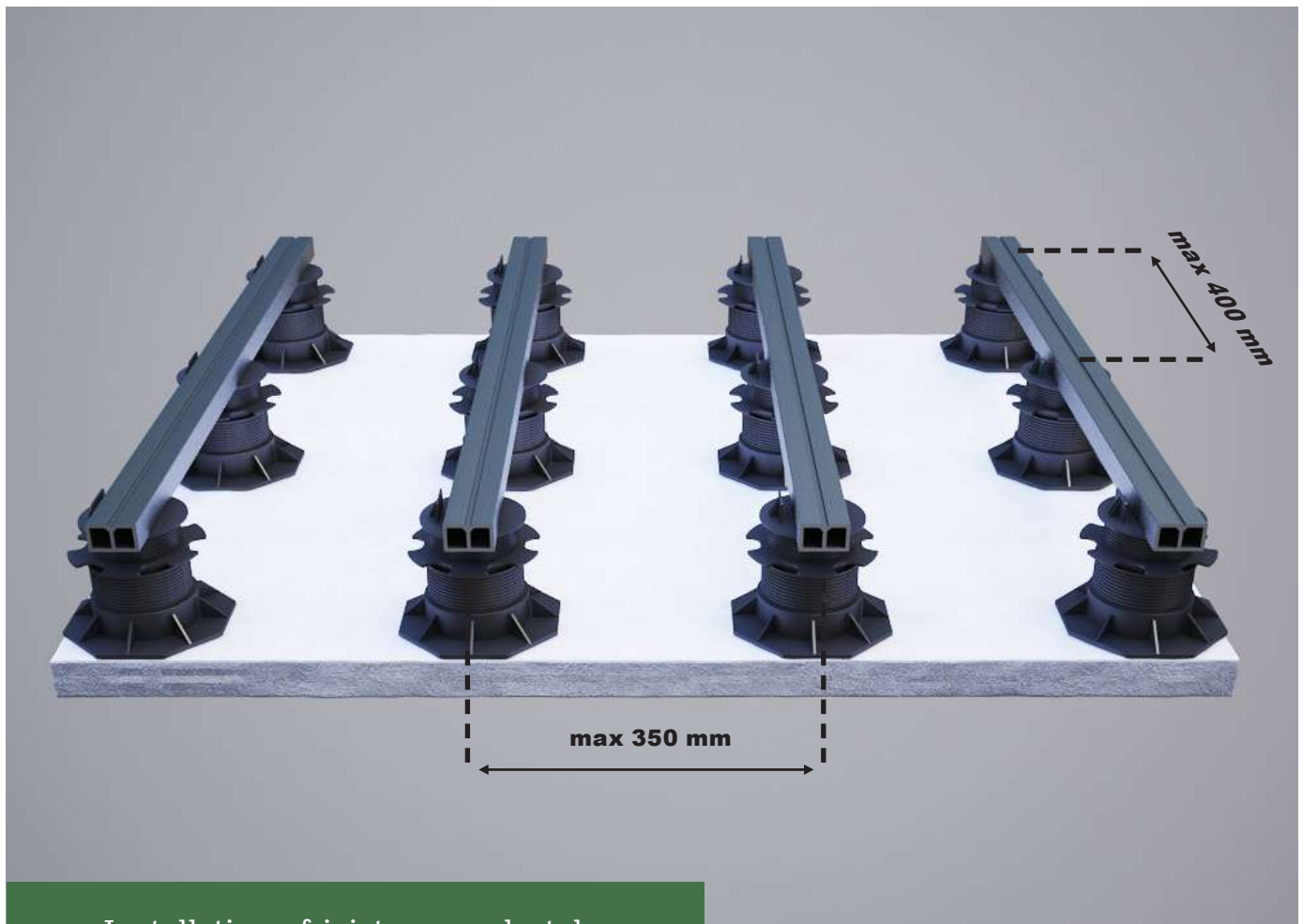

Installation of joists on pedestals

It is possible to install joists on plastic pedestals designed to support the system. The brackets are adjustable, allowing for the desired height adjustment of the deck.



### During the installation please keep in mind:

- The joist must have a minimum of 3 support points. The distance between them should not exceed 40 cm from the center of the pedestal.
- The maximum spacing between joists should be 350 mm.
- The substrate should be stable, flat and have a 0.5% slope (10 mm per every 2 m) in the direction away from the wall.
- For installation on pedestals it is recommended to use joists with dimensions of 30x50 mm.

## Decking boards installation

The boards are attached to the joist structure using clips.

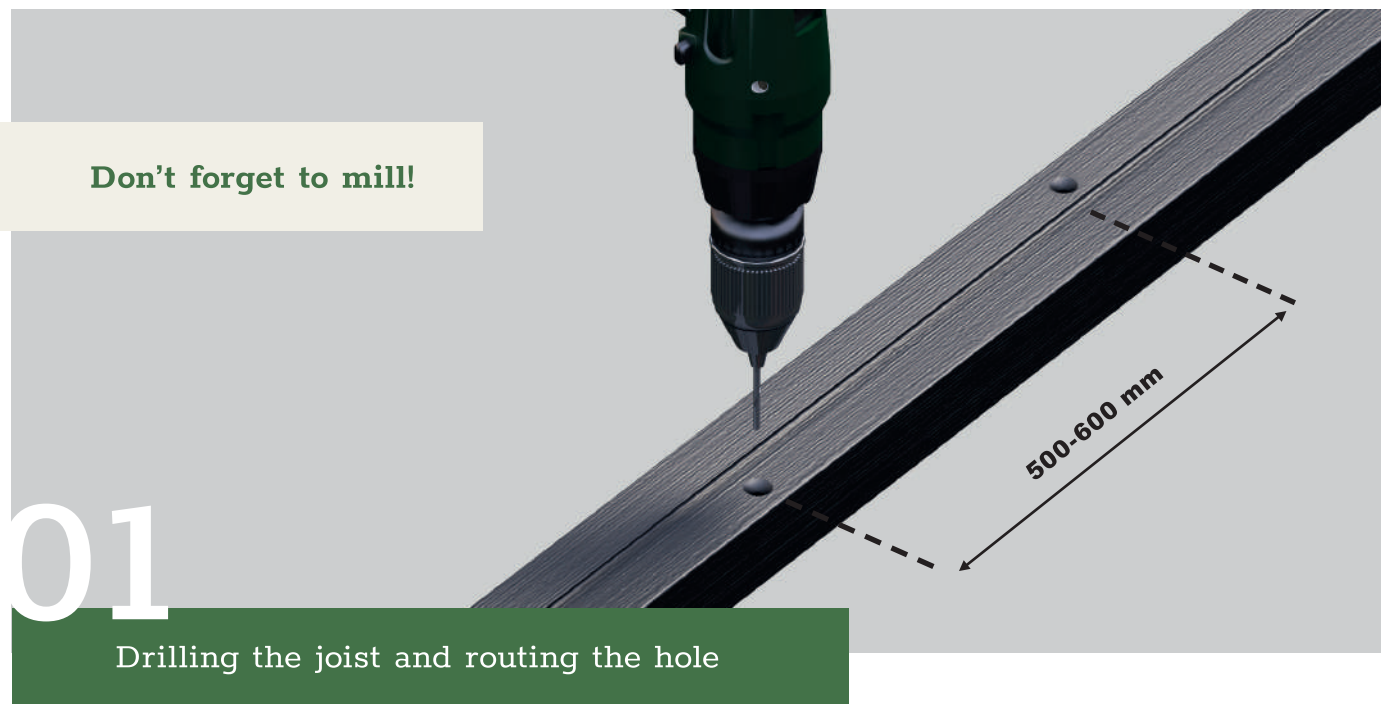

First, drill the joist using a 6 mm metal drill bit. Then, place the joist on the floor and mark the drilling points on the concrete. After removing the joist, drill the holes in the concrete floor using a 6 mm concrete drill bit, spacing them approximately every 500-600 mm. Alternate the drilling positions on the joist as shown in the diagram above. Before installing the plugs, use a router or countersink bit to chamfer the holes.

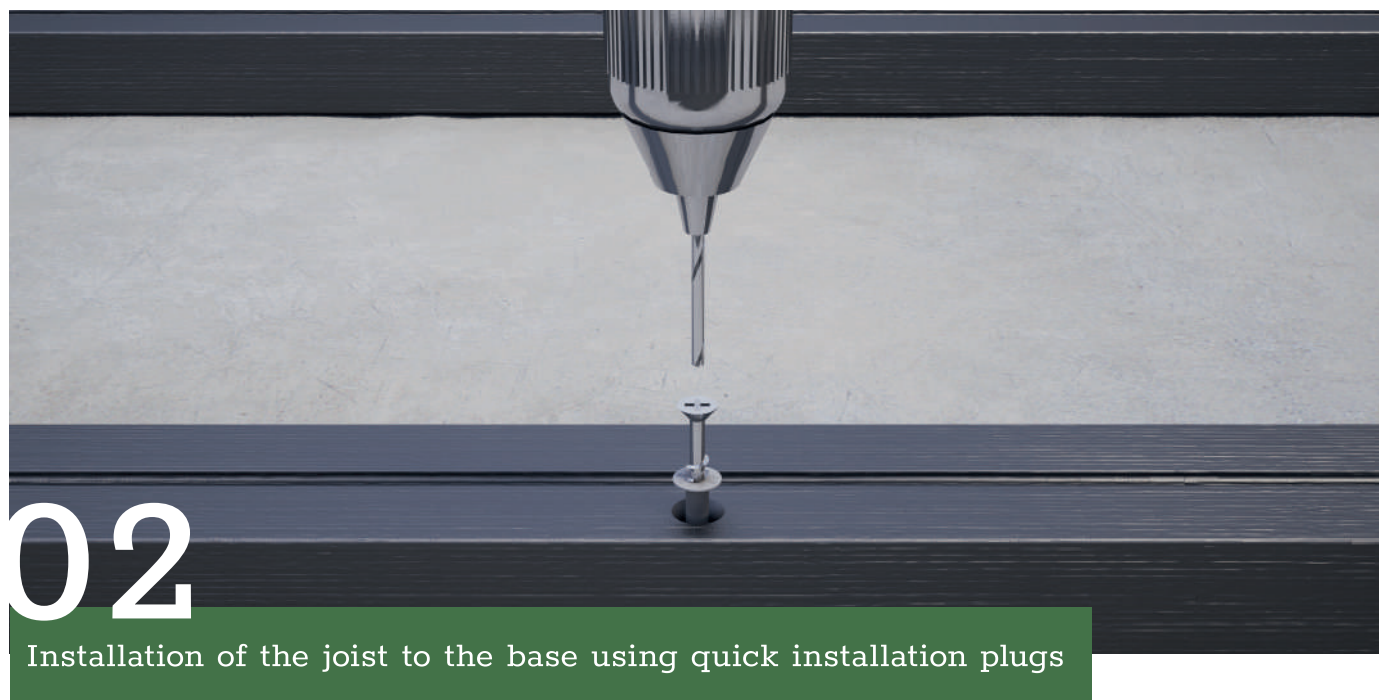

The joist should be mounted to the substrate using quick installation plugs measuring 6 x 60 mm or 6 x 80 mm, depending on the requirements.





Drilling the joist for the starting clip

In the center of the joist, drill a hole using a 3 mm metal drill bit. Not drilling a hole in the joist may result in improper installation of the clip and uneven attachment.



Installing the starting clip

The starting clip is attached to the edge of the joist using the provided screws. The embossment on the clip should align with the groove on the joist. Remember to maintain a minimum of 10 mm spacing between the joists and the building or other fixed elements.

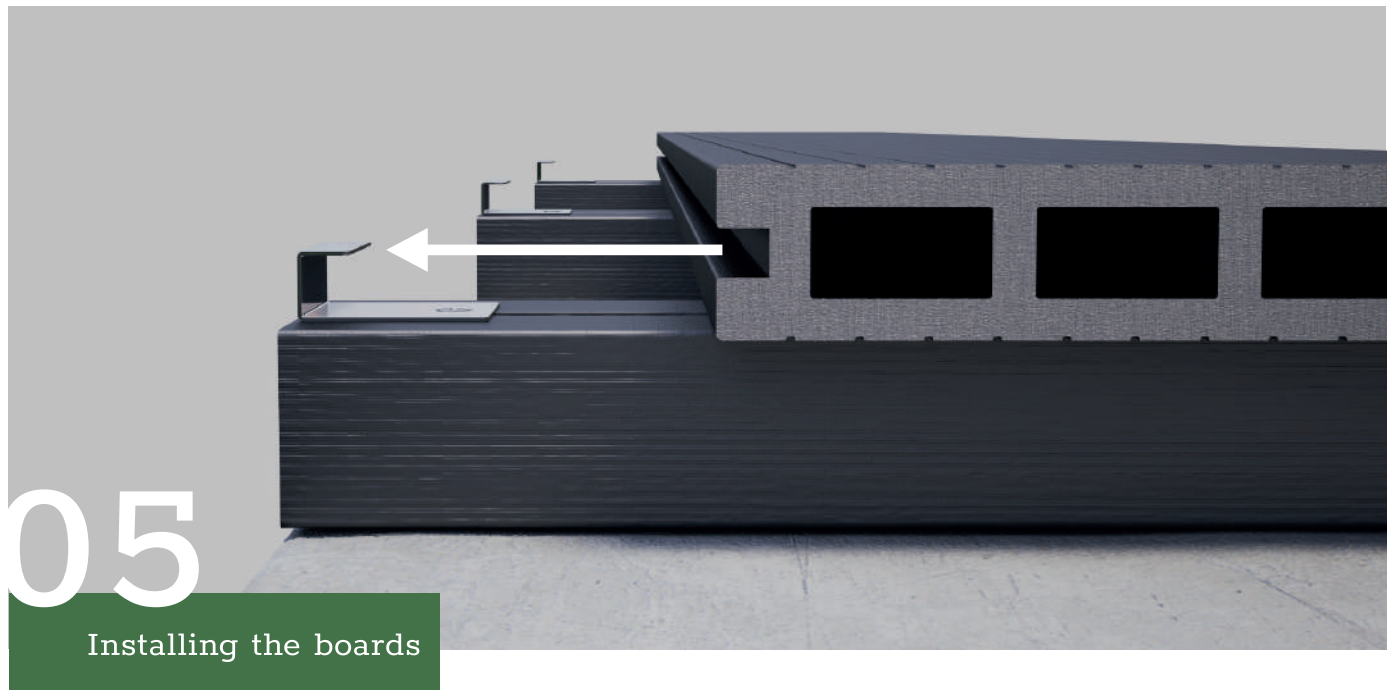

Insert the decking board into the starting clip, ensuring a snug fit. The board should align with the clip and fit securely into place.



Drill a hole using a 3 mm metal drill bit. Not drilling a hole in the joist may result in improper installation of the clip and uneven attachment.

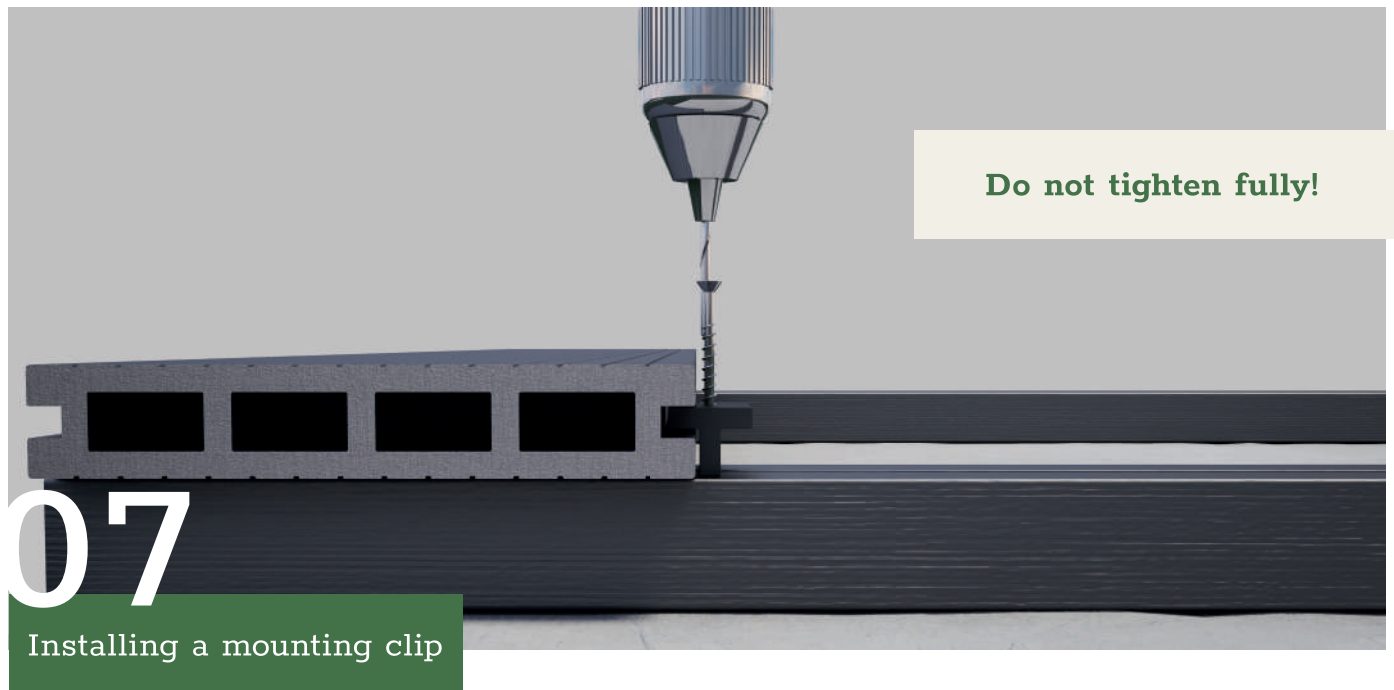

Loosely screw the clip in place using the provided screws. At this stage, do not tighten the screws fully!

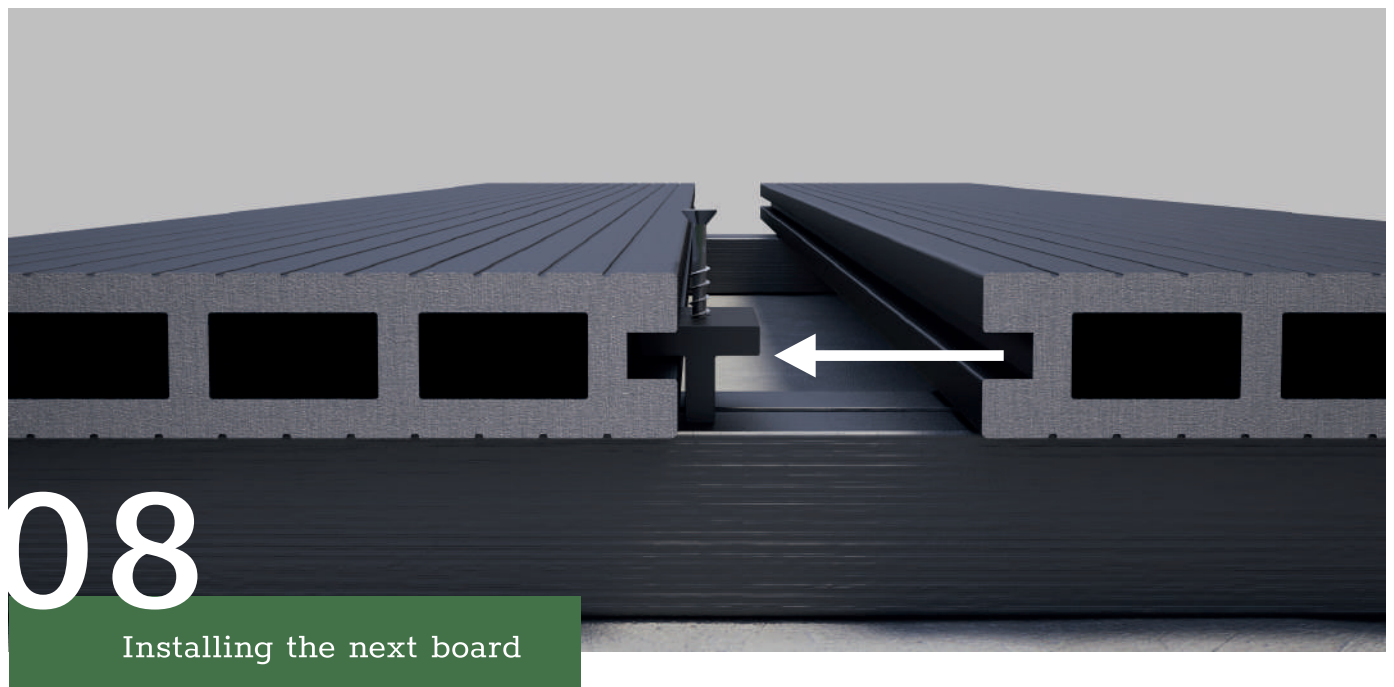

The decking board should be pushed into the previously loosely attached mounting clip, ensuring a secure fit. To achieve better alignment and fit, you can gently tap the board with a rubber mallet. WPC clips are not expansion joints. Maintain an additional gap of approximately 1 mm between the board and the clip's foot. During the installation of composite components, always consider their shrinkage and expansion properties depending on the weather conditions, as composite materials behave similarly to natural wood.

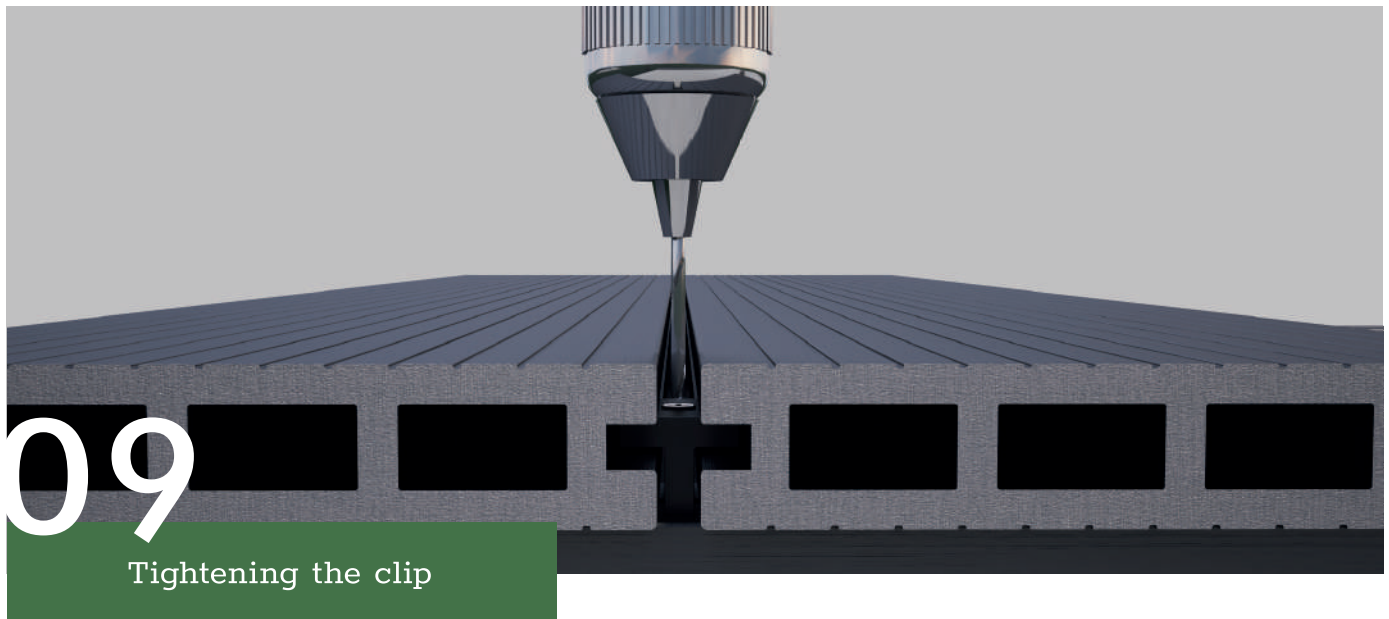

Next, fully tighten the screw until it is completely secured. For plastic clips, it is recommended to tighten the screw using a medium torque setting. The clip should be tightened in a way that the board is firmly held in place, but still has some room for expansion and contraction.



When using a drill by our installers, we set the speed to 8 out of the available 18 settings.

## Longitudinal board alignment

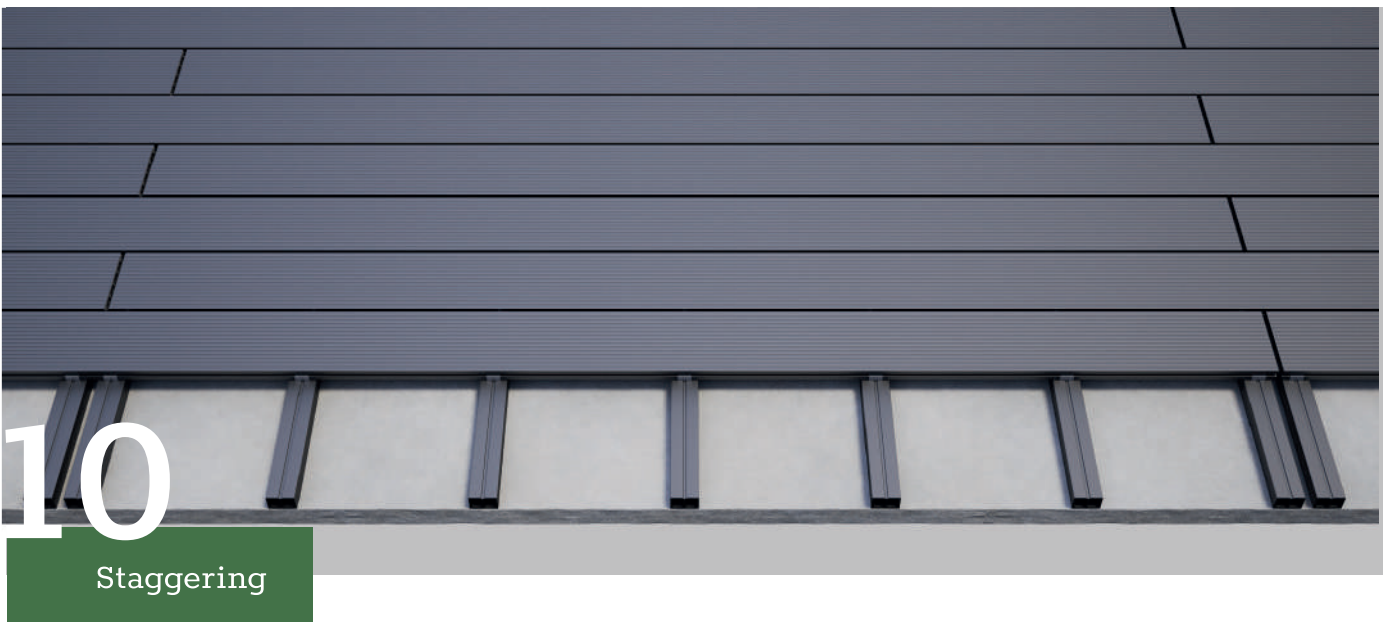

When joining boards of different lengths, it is recommended to lay them alternately using a technique called *staggering*. The ends of the boards should rest on separate joists and be secured with individual clips. A minimum gap of 10 mm should be maintained between longitudinally laid boards.

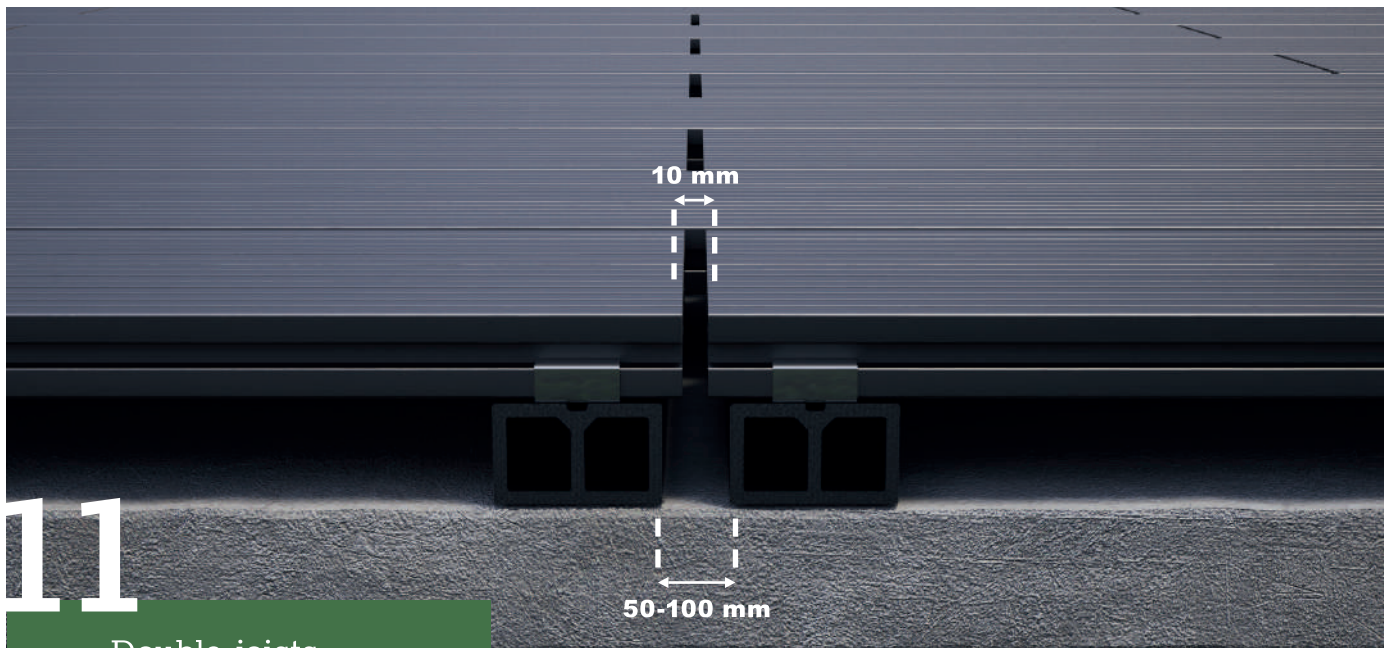

Double joists

For decks with non-standard shapes or larger areas, it is recommended to use a double joist system. The spacing between double joists should be 50-100 mm, while the gap between boards should be 10 mm.

## Decking trims

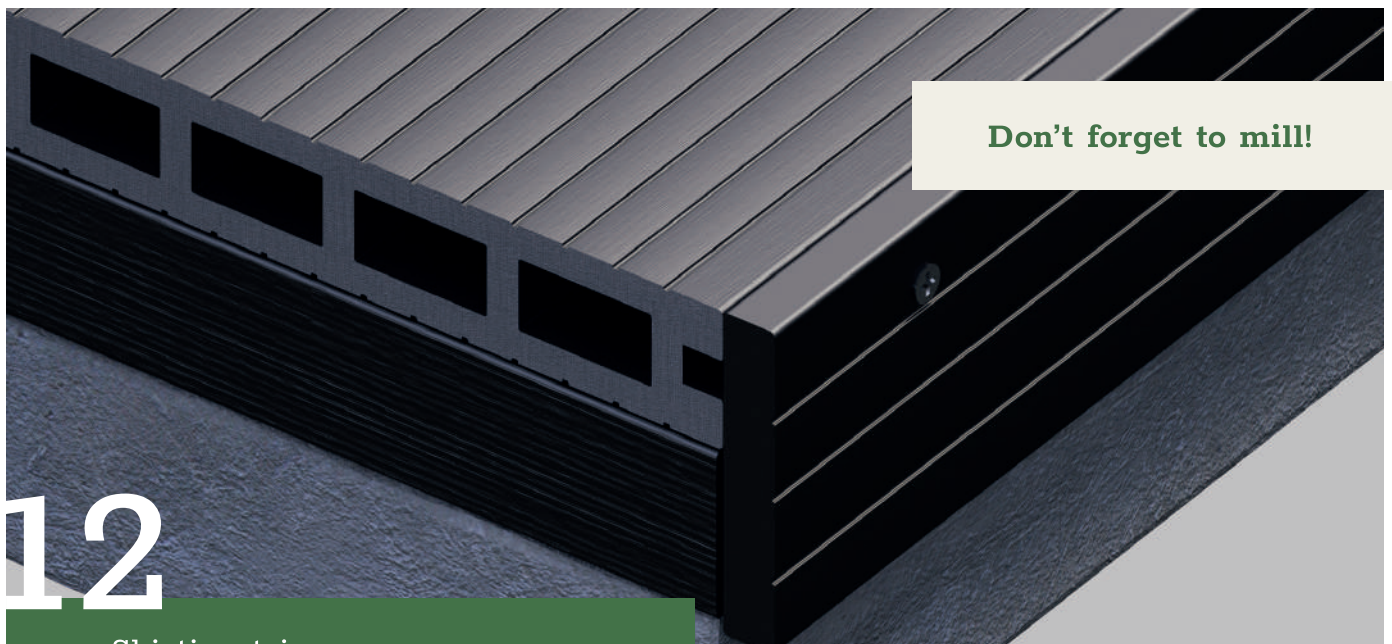

Skirting trim

We recommend installing the skirting trim with the assistance of an additional person. Place the trim against the board and then drill holes from the top of the trim and the board using a 3 mm metal drill bit. Use a countersink bit to deepen the holes. Failure to drill may result in the trim cracking. Install the screws at a medium torque at approximately 350 mm intervals. Start the installation from the center of the trim. Maintain a gap of approximately 3 mm between the trim pieces.



Don't forget to mill!

13

L-shaped edge trim

We recommend installing the skirting trim with the assistance of an additional person. Place the trim against the board and then drill holes from the top of the trim and the board using a 3 mm metal drill bit. Use a countersink bit to deepen the holes. Failure to drill may result in the trim cracking. Install the screws at a medium torque at approximately 350 mm intervals. We recommend starting the installation from the center of the trim. In the corners, cut the trim pieces at a 45° angle. Maintain a gap of approximately 3 mm between the trim pieces.

EcoTRAVERS®

GOT QUESTIONS?

Contact us.



info@ecotravers.com

www.ecotravers.com